





产品图片	Features 产品特性	Application 应用
 DIP8  SMD8	<ul style="list-style-type: none"> ●Contact Form 触点形式 2a ●Load Voltage 输出电压 200V ●Load Current 输出电流 0.18A ●Low Off-State Leakage Current 漏电流 1μA 	<ul style="list-style-type: none"> ●Automatic Test Equipment 自动检测设备 ●Telephone Equipment 通信设备 ●Sensing Equipment 传感设备 ●Security Equipment 安全设备 ●I/O Modules I/O 模块 ●Modem 调制解调器

Type 种类

Output rating 输出额定		Marking model 标刻型号	Part No. 订货型号	
Load voltage 负载电压	Load current 负载电流		DIP 双列直插	SMD 表面贴装
200V	0.18A	BCW217	BCW217	BCW217

Dimensions 外形尺寸

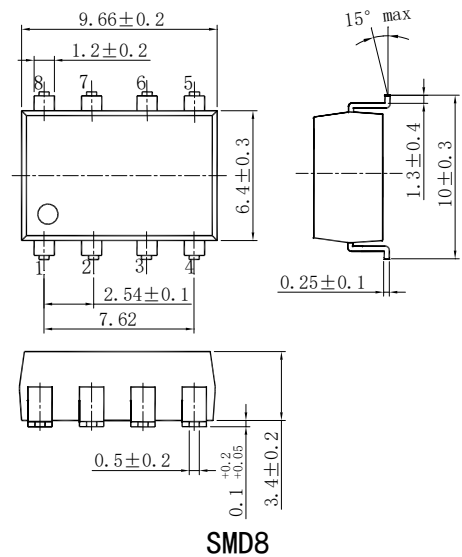
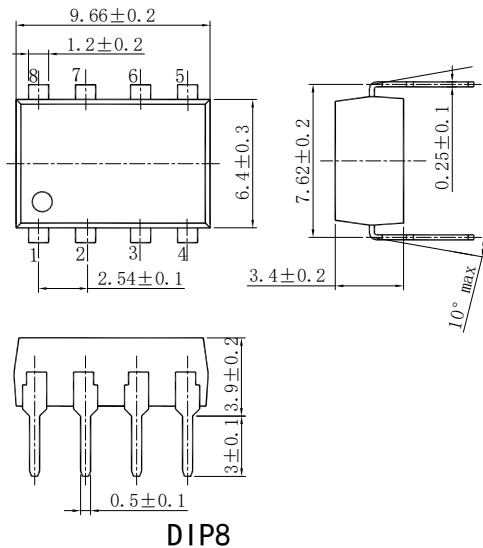

Terminal Identification

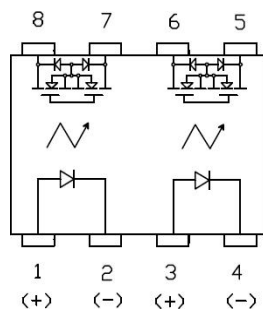

引脚标识 Wiring Diagram 接线图

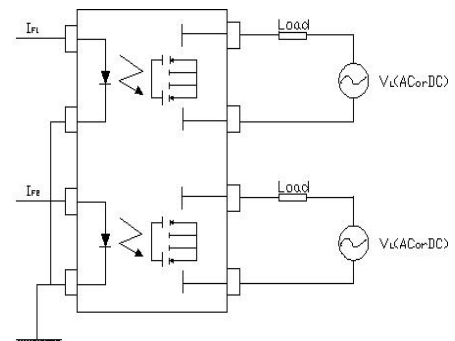



PhotoMOS 光 MOS 继电器 (SMD8/DIP8)

Technical parameters 技术参数 (Ambient Temperature 25°C)

I/O Absolute Maximum Ratings 输入输出电气参数最大值

Item 项目	Symbol 符号	BCW217		
Operating Temperature 工作温度	T_{OPR}	-40°C~+85°C		
Storage Temperature 储存温度	T_{STG}	-40°C~+100°C		
Input 输入	Continuous LED Current 工作电流	MAX. 最大值	I_F	50mA
	Peak LED Current LED 峰值电流 (f=100Hz, Duty=1%)	MAX. 最大值	I_{FP}	1000mA
	LED Reverse Voltage 反向电压	MAX. 最大值	V_R	5V
	Input Power Dissipation 输入功耗	MAX. 最大值	P_{IN}	75mW
Output 输出	Load Voltage 输出电压	MAX. 最大值	V_L	200V (AC peak or DC)
	Load Current 输出电流	MAX. 最大值	I_L	0.18A
	Peak Load Current 峰值输出电流 (100ms, 1shot)	MAX. 最大值	I_{PEAK}	0.6A
	Output Power Dissipation 输出功耗	MAX. 最大值	P_{OUT}	450mW
Total Power Dissipation 总功耗	MAX. 最大值	P_T	500mW	
I/O Breakdown Voltage 输入输出间隔离电压	MAX. 最大值	$V_{I/O}$	3750Vrms	
I/O Breakdown Voltage 输入输出间隔离电压 (加注 H)	MAX. 最大值	$V_{I/O}$	5000Vrms	

Electrical Specifications 输入输出电气参数

Item 项目	Symbol 符号	BCW217	Conditions 条件		
Input 输入	LED Forward Voltage 正向电压	TYP. 典型值	V_F	1.3V	$I_F=10mA$
		MAX. 最大值		1.5V	
	Operation LED Current 接通电流	TYP. 典型值	$I_{F ON}$	0.5mA	
		MAX. 最大值		2mA	
Recovery LED Voltage 关断电压	MIN. 最小值	$V_{F OFF}$	0.7V		
Output 输出	On-Resistance 导通电阻	TYP. 典型值	R_{ON}	5Ω	$I_F=5mA, I_L=100mA,$ within 1sec.
		MAX. 最大值		8Ω	
	Off-State Leakage Current 漏电流	MAX. 最大值	I_{LEAK}	1μA	$V_L=Rating$
Output Capacitance 输出端容量	TYP. 典型值	C_{OUT}	115pF	$V_L=0V, f=1MHz$	
Time parameters 时间参数	Turn-On Time 接通时间	TYP. 典型值	T_{ON}	0.4ms	$I_F=5mA, I_L=100mA$
		MAX. 最大值		0.8ms	
	Turn-Off Time 关断时间	TYP. 典型值	T_{OFF}	0.05ms	
		MAX. 最大值		0.2ms	
I/O 输入输出	I/O Insulation Resistance 绝缘电阻	MIN. 最小值	$R_{I/O}$	1000MΩ	DC500V
	I/O Capacitance 隔离电容	TYP. 典型值	$C_{I/O}$	0.8pF	f=1MHz

通讯地址: 陕西省西安市国家民用航天产业基地航天中路385号众创广场11层1101.1102.1104室

生产地址: 陕西省宝鸡市陈仓区群力路1号 邮政编码: 721300

电话: (0917)-6293969 18609177833

传 真: (0917)-6293969



Reference Data 参考数值 (BCW217)

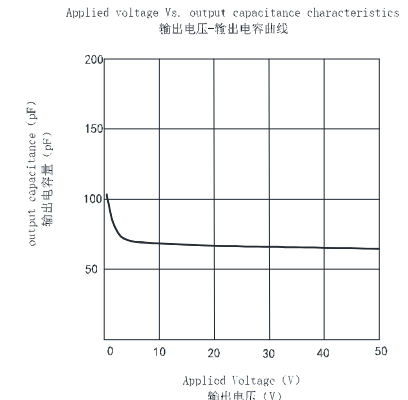
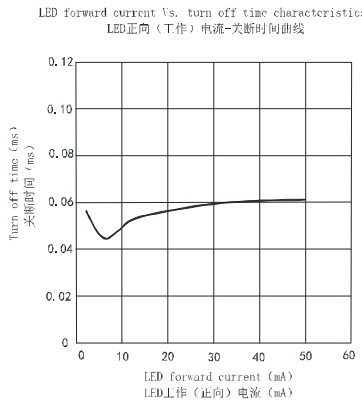
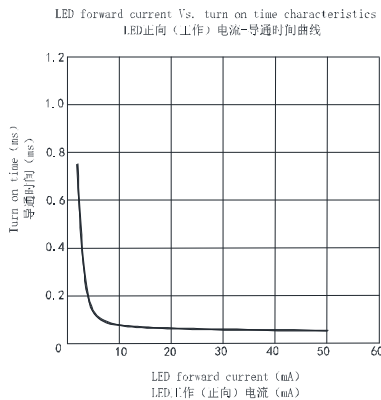
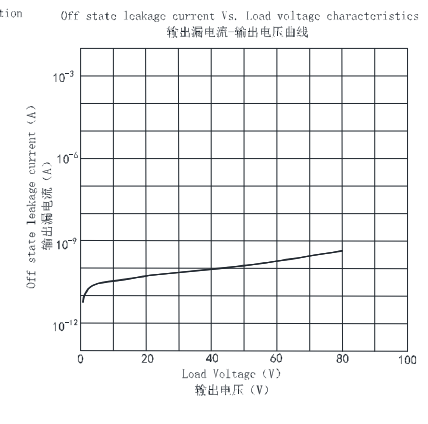
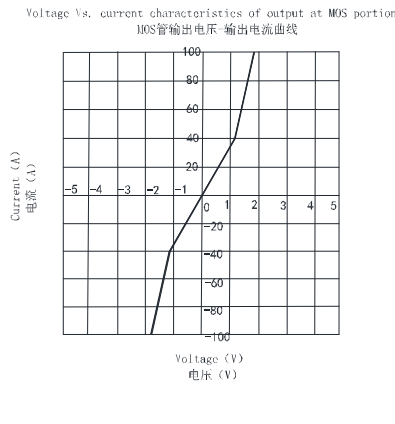
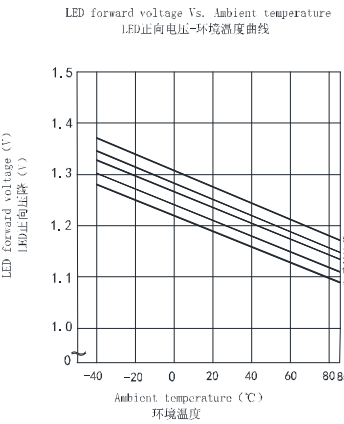
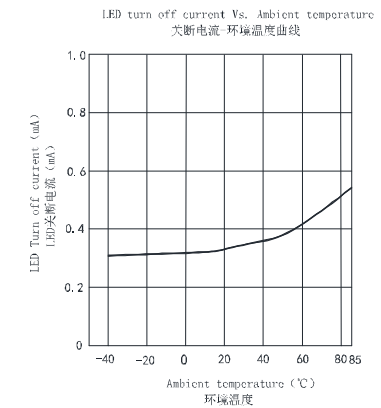
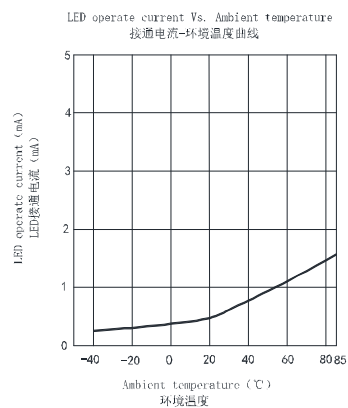
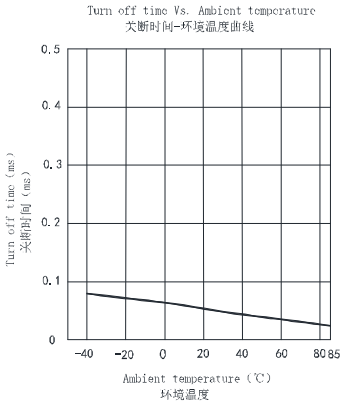
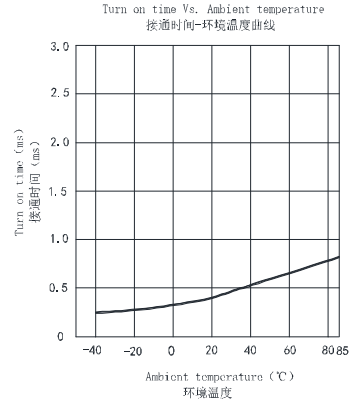
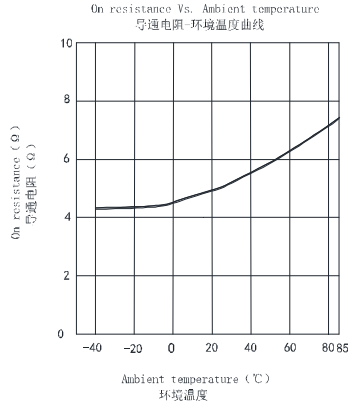
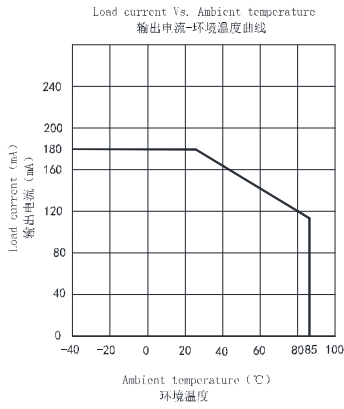

通讯地址: 陕西省西安市国家民用航天产业基地航天中路385号众创广场11层1101.1102.1104室

生产地址: 陕西省宝鸡市陈仓区群力路1号 邮政编码: 721300

电话: (0917)-6293969 18609177833

传 真: (0917)-6293969