

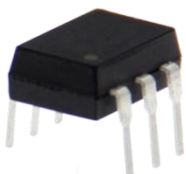



# BCV215G 型光 MOS 继电器

产品图片	Features 产品特性	Application 应用
 <b>DIP6</b>	<ul style="list-style-type: none"> <li>●Contact Form 触点形式 1a</li> <li>●Load Voltage 输出电压 100V</li> <li>●Load Current 输出电流 2A</li> <li>●Low Off-State Leakage Current 漏电流 1.0 μA</li> </ul>	<ul style="list-style-type: none"> <li>●Automatic Test Equipment 自动检测设备</li> <li>●Security Equipment 安全设备</li> <li>●Sensing Equipment 传感设备</li> <li>●Telephone Equipment 通信设备</li> <li>●I/O Modules I/O 模块</li> <li>●Modem 调制解调器</li> </ul>
 <b>SMD6</b>		

## Type 种类

Output rating 输出额定		Marking model 标 刻型号	Part No. 订货型号	
Load voltage 负载电压	Load current 负载电流		DIP 双列直插	SMD 表面贴装
100V	2A	BCV215G	BCV215G	BCV215GA

注：表示引脚类型的“A”未标刻在产品上，订货依据订货示例型号。

## Dimensions 外形尺寸

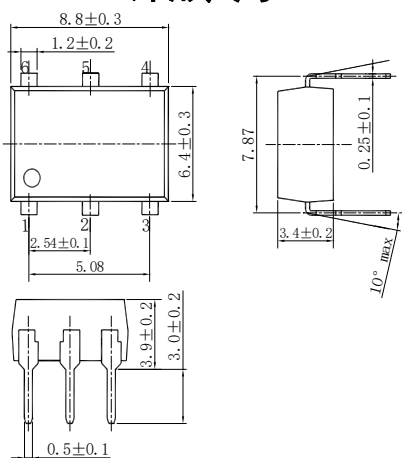

**DIP6**

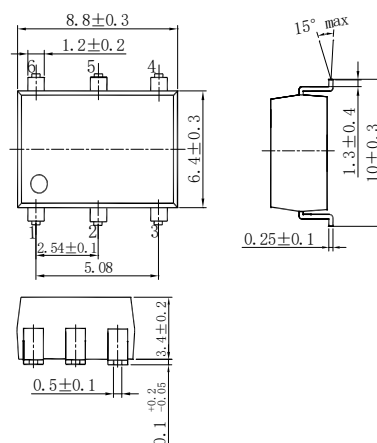

**SMD6**

## Terminal Identification 引脚标识

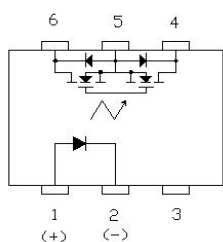

## Wiring Diagram 接线图

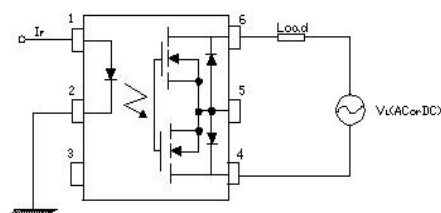

通讯地址：陕西省西安市国家民用航天产业基地航天中路385号众创广场11层1101、1102、1104室

生产地址：陕西省宝鸡市陈仓区群力路1号 邮政编码：721300

电话：(0917)-6293969 (0917)-6293785 传真：(0917)-6293969



## BCV215G 型光 MOS 继电器

## Technical parameters 技术参数 (Ambient Temperature 25°C)

## I/O Absolute Maximum Ratings 输入输出电气参数最大值

Item 项目		Symbol 符号	Value 数值
Operating Temperature 工作温度		$T_{OPR}$	-40°C~+85°C
Storage Temperature 储存温度		$T_{STG}$	-40°C~+100°C
Input 输入	Continuous LED Current 工作电流	$I_F$	50mA
	Peak LED Current LED 峰值电流 (f=100Hz, Duty=1%)	$I_{FP}$	1000mA
	LED Reverse Voltage 反向电压	$V_R$	5V
	Input Power Dissipation 输入功耗	$P_{IN}$	75mW
Output 输出	Load Voltage 输出电压	$V_L$	100V (AC peak or DC)
	Load Current 输出电流	$I_L$	2A
	Peak Load Current 峰值输出电流 (1ms, 1 shot)	$I_{PEAK}$	6A
	Output Power Dissipation 输出功耗	$P_{OUT}$	350mW
Total Power Dissipation 总功耗		$P_T$	400mW
I/O Breakdown Voltage 输入输出间隔离电压		$V_{I/O}$	3750Vrms
I/O Breakdown Voltage 输入输出间隔离电压 (加注 H)		$V_{I/O}$	5000Vrms

## Electrical Specifications 输入输出电气参数

Item 项目		Symbol 符号	MIN. 最小值	TYP. 典型值	MAX. 最大值	Units 单位	Conditions 条件
Input 输入	LED Forward Voltage 正向电压	$V_F$		1.2	1.4	V	$I_F=10mA$
	Operation LED Current 接通电流	$I_{F ON}$		1.0	3.0	mA	
	Recovery LED Voltage 关断电压	$V_{F OFF}$	0.7			V	
Output 输出	On-Resistance 导通电阻	$R_{ON}$		0.15	0.25	$\Omega$	$I_F=5mA, I_L=100mA$ (with in 1sec.)
	Off-State Leakage Current 漏电流	$I_{LEAK}$			1.0	$\mu A$	$V_L=Rating$
	Output Capacitance 输出端容量	$C_{OUT}$		115		pF	$V_L=0V, f=1MHz$
Time parameters 时间参数	Turn-On Time 接通时间	$T_{ON}$		1.0	3.0	ms	$I_F=5mA, I_L=100mA$
	Turn-Off Time 关断时间	$T_{OFF}$		0.35	0.5	ms	
I/O 输入输出	I/O Insulation Resistance 绝缘电阻	$R_{I/O}$	1000			M $\Omega$	DC500V
	I/O Capacitance 隔离电容	$C_{I/O}$		0.8	1.5	pF	f=1MHz

通讯地址: 陕西省西安市国家民用航天产业基地航天中路385号众创广场11层1101、1102、1104室

生产地址: 陕西省宝鸡市陈仓区群力路1号 邮政编码: 721300

电话: (0917)-6293969 (0917)-6293785 传真: (0917)-6293969



# BCV215G 型光 MOS 继电器

## Reference Data 参考数值 (BCV215G)

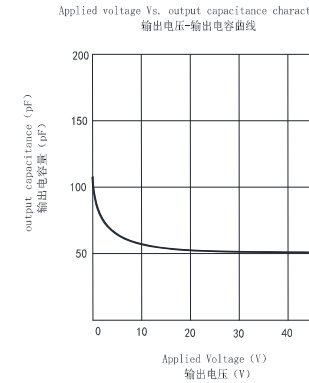
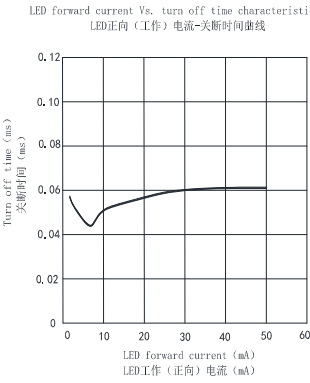
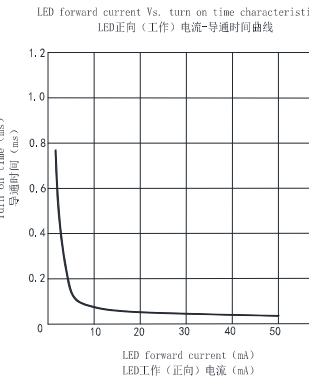
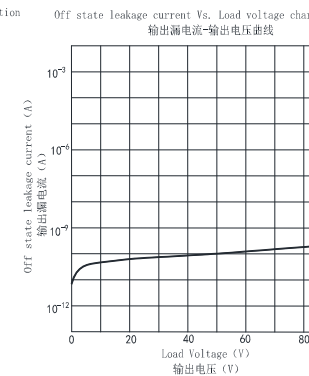
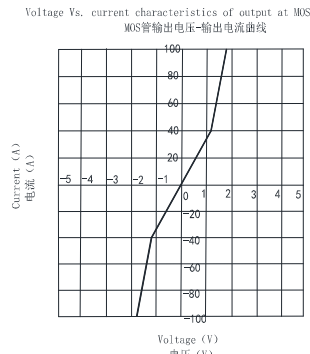
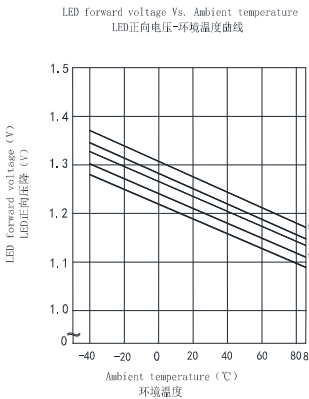
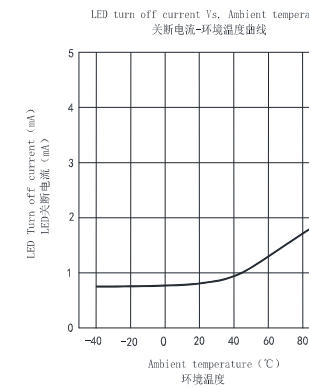
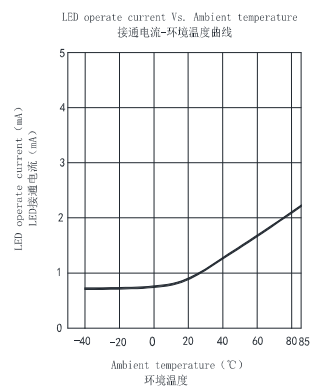
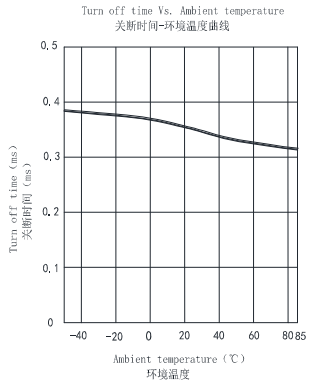
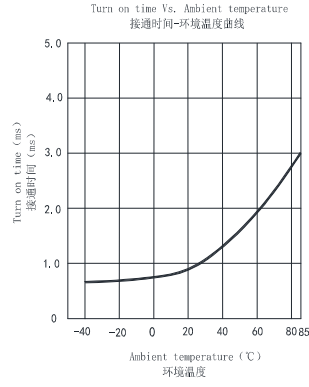
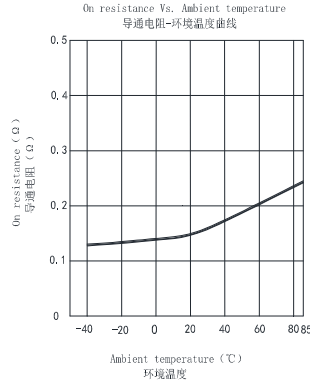
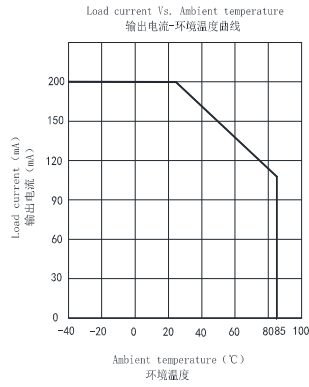

通讯地址: 陕西省西安市国家民用航天产业基地航天中路385号众创广场11层1101.1102.1104室  
 生产地址: 陕西省宝鸡市陈仓区群力路1号 邮政编码: 721300  
 电话: (0917)-6293969 18609177833 传 真: (0917)-6293969